



Products Features

- ▶ High resolution, compact.
- ▶ Multi-coated, high transmittance.
- ▶ The sensor size can match with 4/3" 12MP camera.

Parameter

NO.	Item No.	Sensor size	Focal length (mm)	Iris (F#)	Resolution	Standard magnification	Mount	Relative illumination (%)	Filter screw size	WD (mm)
1	SBS-1220-12MP	4/3"	12	2.0-22	12MP	0.038	C	>65	M77*P0.75	150-∞
2	SBS-1620-12MP	4/3"	16	2.0-22	12MP	0.035	C	>65	M58*P0.75	100-∞
3	SBS-2520-12MP	4/3"	25	2.0-22	12MP	0.069	C	>70	M46*P0.75	150-∞
4	SBS-3520-12MP	4/3"	35	2.0-22	12MP	0.089	C	>70	M46*P0.75	200-∞
5	SBS-5020-12MP	4/3"	50	2.0-22	12MP	0.097	C	>70	M46*P0.75	300-∞

Model No.	Back focus (mm)	Distortion			Field of view								
					4/3"			1"			1/2"		
		4/3"	1"	1/2"	D	H	V	D	H	V	D	H	V
SBS-1220-12MP	18.8 in air	-2.05%@y=11.5mm	-1.73%@y=8.0mm	-1.01%@y=4.0mm	89.10°	75.60°	61.20°	69.00°	57.36°	44.30°	37.40°	30.20°	22.70°
SBS-1620-12MP	21.0 in air	-1.93%@y=11.5mm	-1.82%@y=8.0mm	-0.55%@y=4.0mm	73.00°	61.00°	47.30°	54.20°	44.30°	33.60°	28.30°	22.70°	17.10°
SBS-2520-12MP	22.0 in air	-0.64%@y=11.5mm	-0.48%@y=8.0mm	-0.15%@y=4.0mm	49.80°	40.60°	31.10°	35.80°	28.90°	21.80°	18.30°	14.60°	11.10°
SBS-3520-12MP	18.0 in air	-0.52%@y=11.5mm	-0.42%@y=8.0mm	-0.12%@y=4.0mm	36.80°	29.70°	22.50°	26.00°	20.80°	15.80°	13.20°	10.60°	7.90°
SBS-5020-12MP	20.0 in air	-0.13%@y=11.5mm	-0.05%@y=8.0mm	-0.01%@y=4.0mm	26.00°	21.00°	15.80°	18.30°	14.70°	11.10°	9.20°	7.30°	5.60°

WD VS FOV

Working distance (mm)	Optical magnification (x)	4/3" Field of view		1" Field of view		2/3" Field of view	
		H(mm)	V(mm)	H(mm)	V(mm)	H(mm)	V(mm)
		18.0	13.5	12.8	9.6	8.8	6.6
600	-0.019	512.441	384.331	250.527	187.895	182.201	136.651
550	-0.021	471.379	353.534	230.452	172.839	167.601	125.701
500	-0.023	430.318	322.739	210.378	157.783	153.002	114.752
450	-0.025	389.258	291.943	190.304	142.728	138.403	103.802
400	-0.028	348.196	261.147	170.229	127.672	123.803	92.852
350	-0.032	307.135	230.351	150.155	112.616	109.204	81.903
300	-0.037	266.074	199.555	130.080	97.560	94.604	70.953
250	-0.044	225.013	168.760	110.006	82.505	80.005	60.003
200	-0.054	183.951	137.963	89.932	67.449	65.405	49.054
150	-0.069	142.890	107.168	69.858	52.393	50.805	38.104

MTF

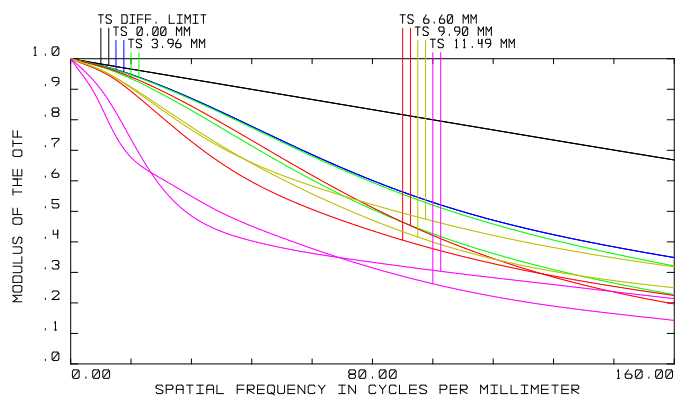

RI

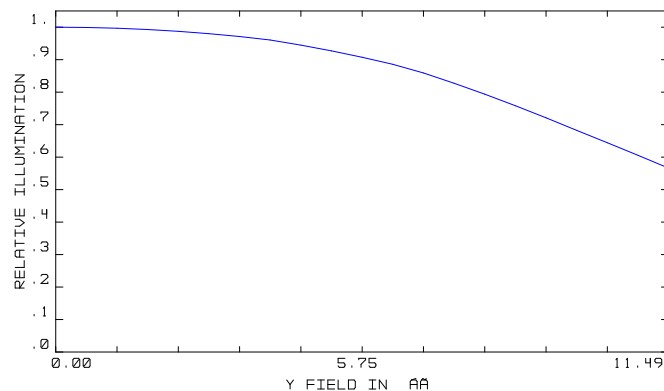

Spot Diagram

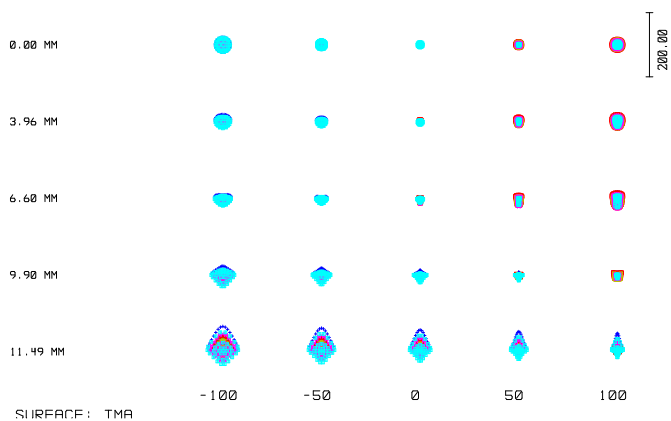

Distortion

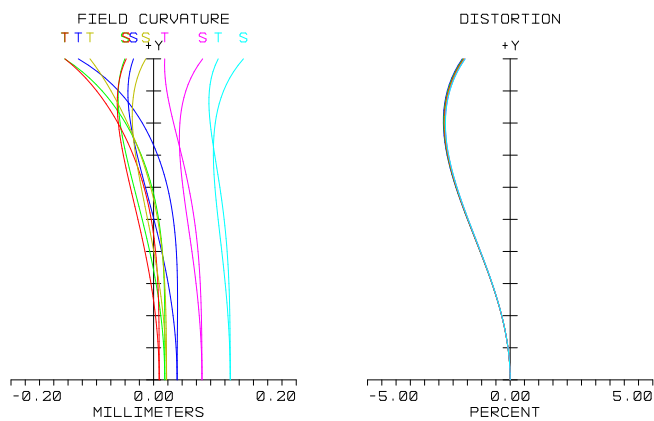



vision solution SBS-1620-12MP

WD VS FOV

Working distance (mm)	Optical magnification (x)	4/3" Field of view		1" Field of view		2/3" Field of view	
		H(mm)	V(mm)	H(mm)	V(mm)	H(mm)	V(mm)
		18.0	13.5	12.8	9.6	8.8	6.6
600	-0.026	363.563	272.672	177.742	133.307	129.267	96.950
550	-0.028	334.318	250.738	163.444	122.583	118.868	89.151
500	-0.031	305.051	228.788	149.136	111.852	108.463	81.347
450	-0.034	275.801	206.851	134.836	101.127	98.063	73.547
400	-0.038	246.582	184.936	120.551	90.413	87.673	65.755
350	-0.043	217.330	162.998	106.250	79.688	77.273	57.955
300	-0.050	188.087	141.065	91.954	68.965	66.875	50.157
250	-0.059	158.838	119.128	77.654	58.240	56.476	42.357
200	-0.072	129.577	97.183	63.349	47.511	46.072	34.554
150	-0.093	100.301	75.226	49.036	36.777	35.663	26.747
100	-0.132	70.978	53.234	34.701	26.025	25.237	18.928

MTF

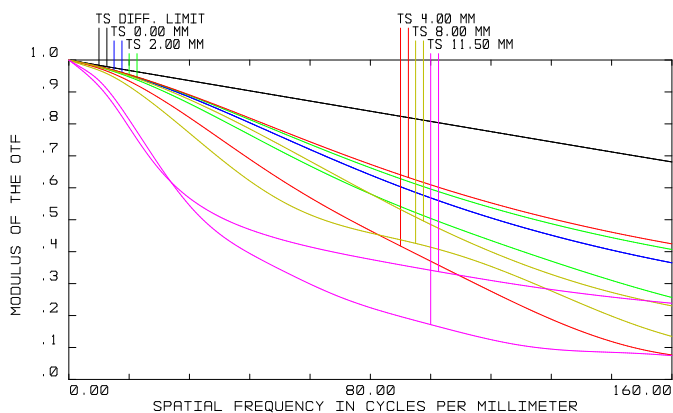

RI

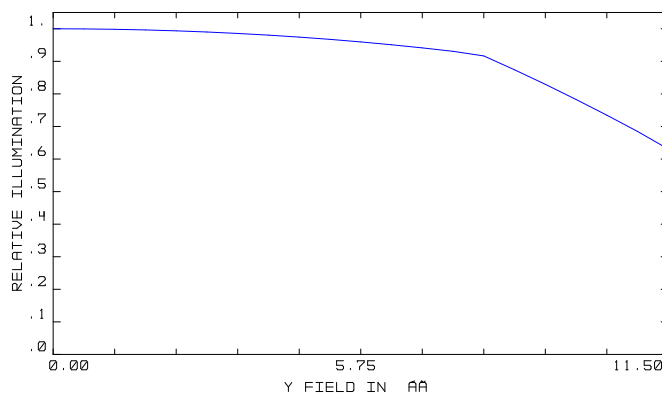

Spot Diagram

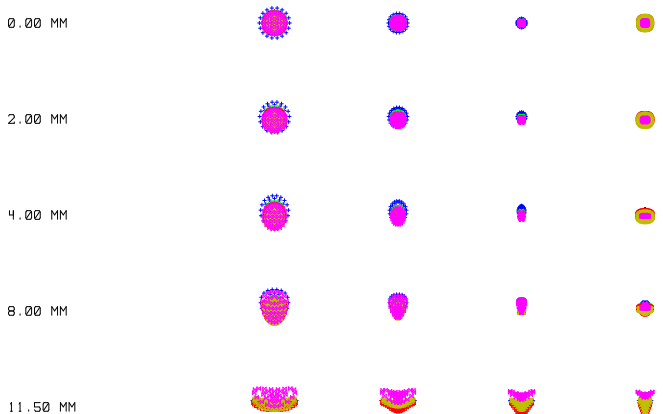

Distortion

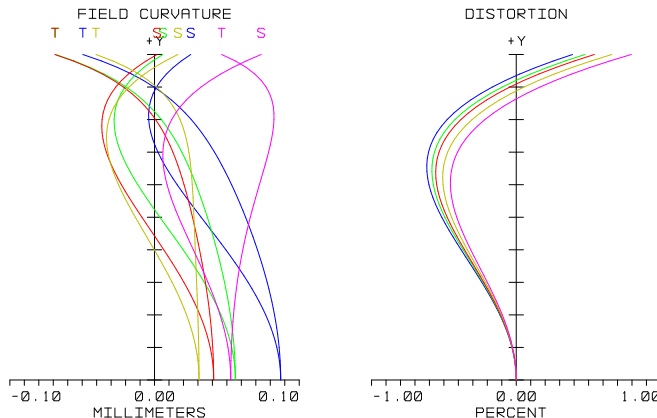

WD VS FOV

Working distance (mm)	Optical magnification (x)	4/3" Field of view		1" Field of view		2/3" Field of view	
		H(mm)	V(mm)	H(mm)	V(mm)	H(mm)	V(mm)
		18.0	13.5	12.8	9.6	8.8	6.6
600	-0.040	228.260	171.195	111.594	83.695	81.159	60.869
550	-0.044	209.844	157.383	102.590	76.943	74.611	55.958
500	-0.048	191.426	143.570	93.586	70.190	68.063	51.047
450	-0.053	173.004	129.753	84.580	63.435	61.513	46.134
400	-0.060	154.566	115.925	75.566	56.674	54.957	41.218
350	-0.068	136.142	102.107	66.559	49.919	48.406	36.305
300	-0.078	117.691	88.268	57.538	43.153	41.846	31.384
250	-0.093	99.236	74.427	48.515	36.387	35.284	26.463
200	-0.114	80.747	60.560	39.476	29.607	28.710	21.533
150	-0.148	62.206	46.655	30.412	22.809	22.118	16.588

MTF

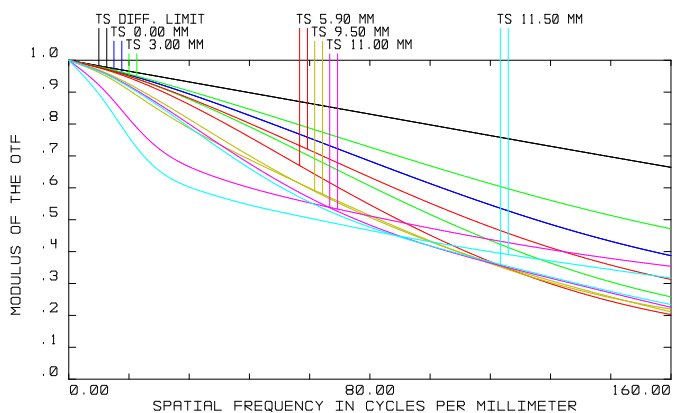

RI

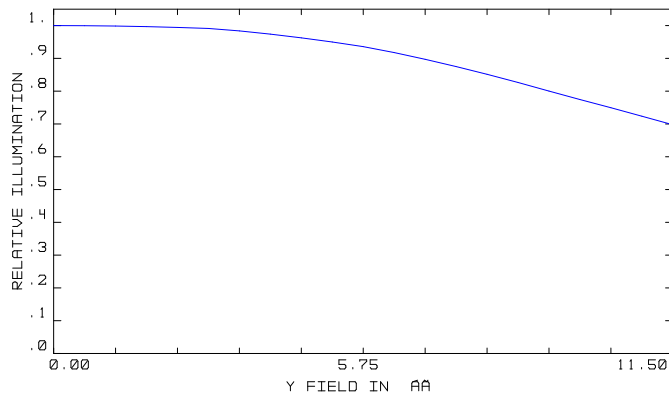

Spot Diagram

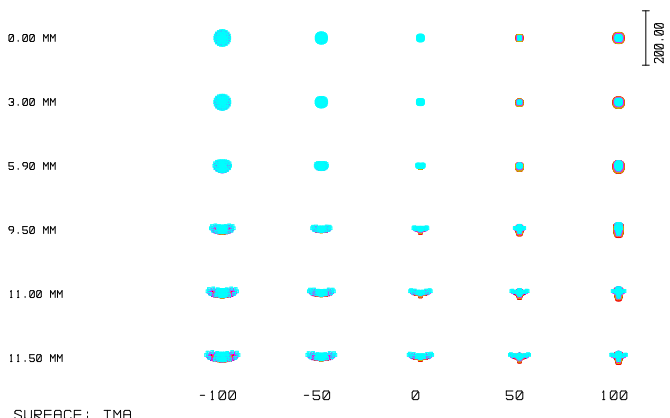

Distortion

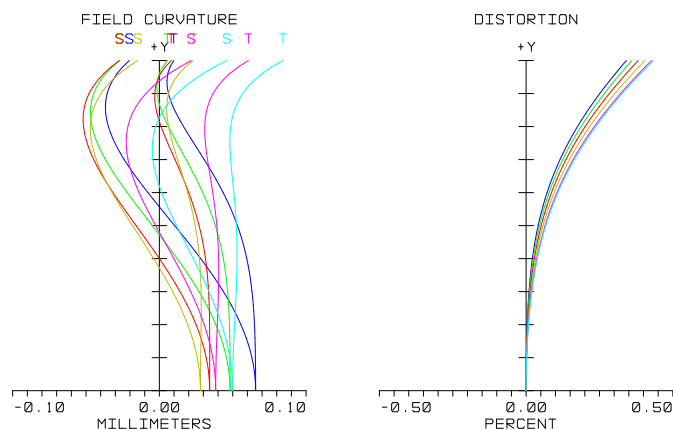



WD VS FOV

Working distance (mm)	Optical magnification (x)	4/3" Field of view		1" Field of view		2/3" Field of view	
		H(mm)	V(mm)	H(mm)	V(mm)	H(mm)	V(mm)
		18.0	13.5	12.8	9.6	8.8	6.6
600	-0.060	153.851	115.388	75.216	56.412	54.703	41.027
550	-0.066	140.650	105.487	68.762	51.572	50.009	37.507
500	-0.072	127.453	95.590	62.310	46.733	45.317	33.987
450	-0.081	114.257	85.693	55.859	41.894	40.625	30.468
400	-0.091	101.060	75.795	49.407	37.055	35.932	26.949
350	-0.105	87.864	65.898	42.956	32.217	31.241	23.430
300	-0.124	74.669	56.002	36.505	27.379	26.549	19.912
250	-0.150	61.474	46.105	30.054	22.540	21.857	16.393
200	-0.191	48.278	36.208	23.602	17.702	17.165	12.874

MTF

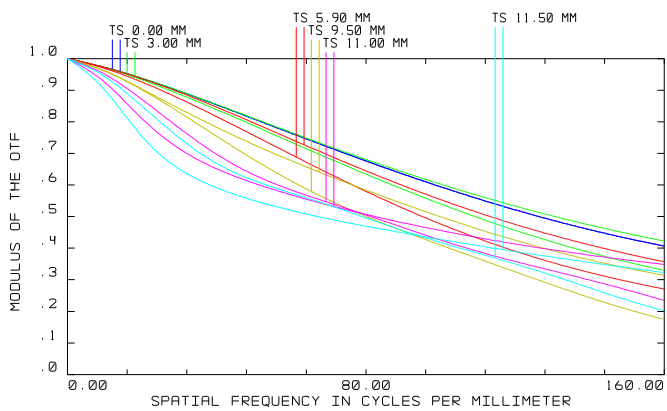

RI

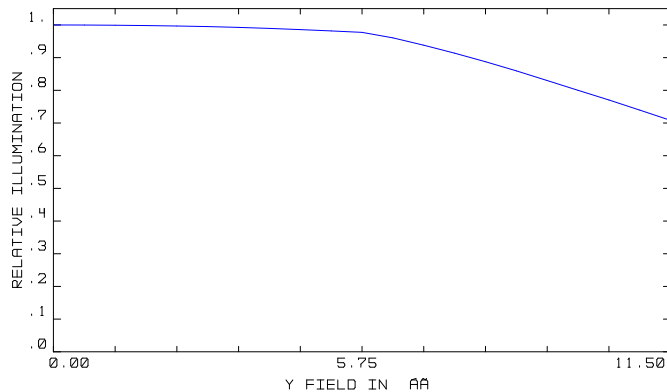

Spot Diagram

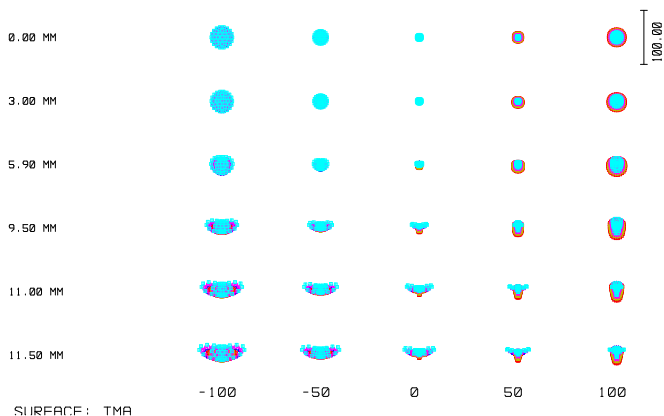

Distortion

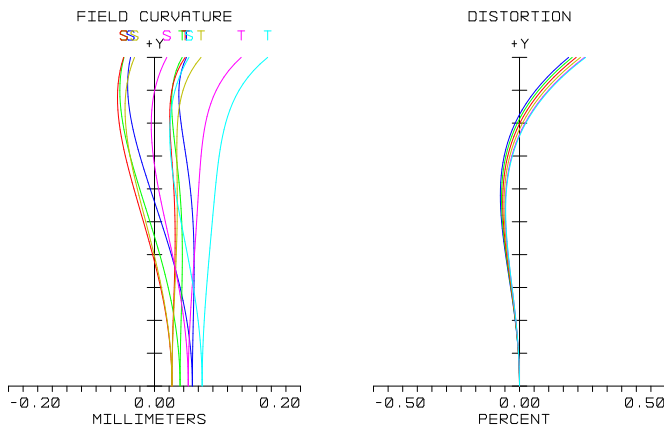

WD VS FOV

Working distance (mm)	Optical magnification (x)	4/3" Field of view		1" Field of view		2/3" Field of view	
		H(mm)	V(mm)	H(mm)	V(mm)	H(mm)	V(mm)
		18.0	13.5	12.8	9.6	8.8	6.6
700	-0.076	121.492	91.119	59.396	44.547	43.197	32.398
650	-0.082	112.253	84.190	54.879	41.159	39.912	29.934
600	-0.090	103.014	77.260	50.362	37.772	36.627	27.470
550	-0.099	93.774	70.330	45.845	34.384	33.342	25.006
500	-0.109	84.542	63.406	41.331	30.999	30.059	22.544
450	-0.123	75.295	56.471	36.811	27.608	26.772	20.079
400	-0.140	66.057	49.543	32.294	24.221	23.487	17.615
350	-0.163	56.818	42.613	27.777	20.833	20.202	15.151
300	-0.194	47.582	35.686	23.262	17.447	16.918	12.688

MTF

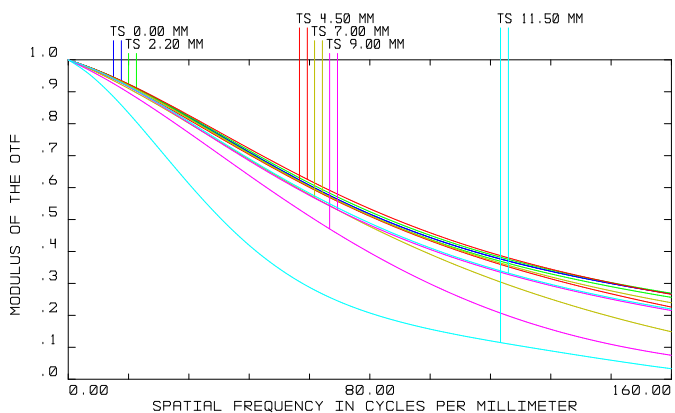

RI

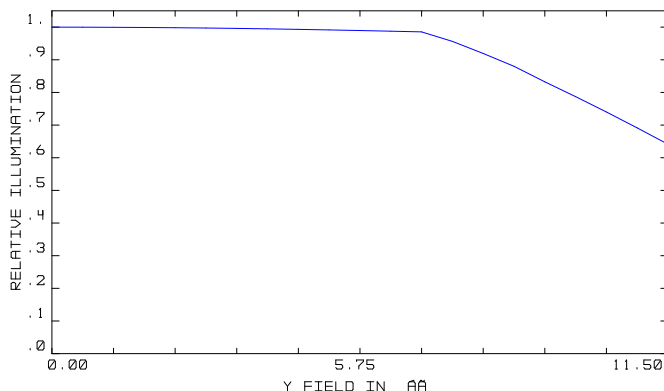

Spot Diagram

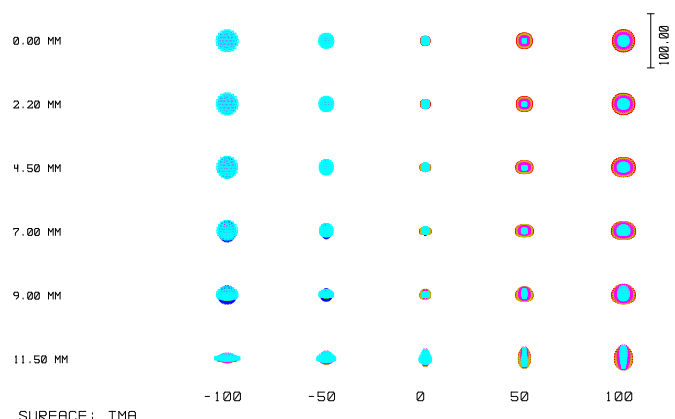

Distortion

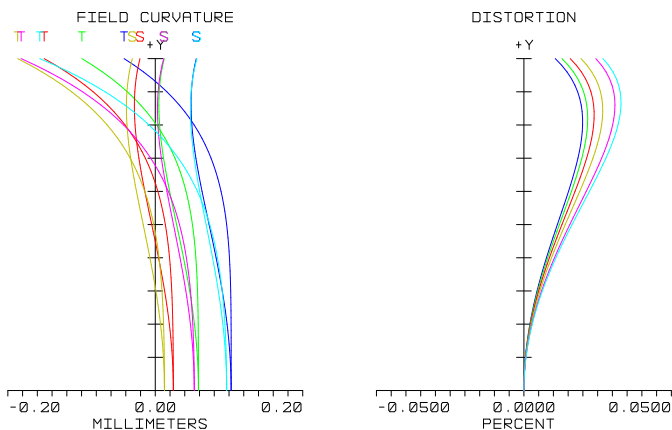



vision solution Dimensions for 4/3" 12MP series Focal Lens

Dimensions (mm)

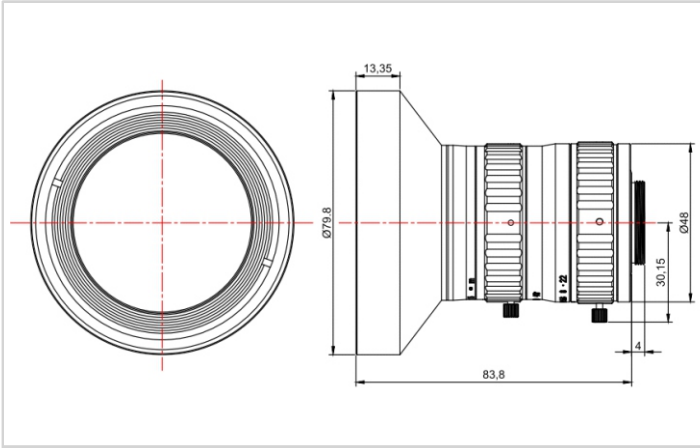

SBS-1220-12MP

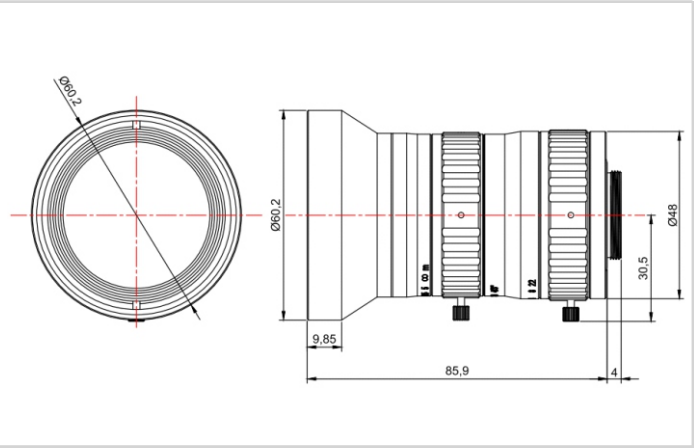

SBS-1620-12MP

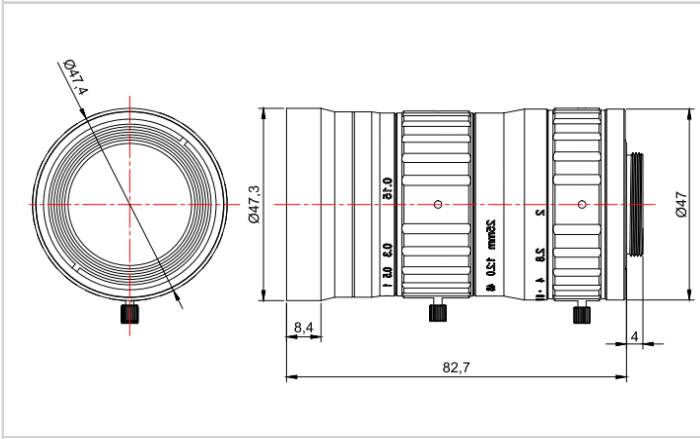

SBS-2520-12MP

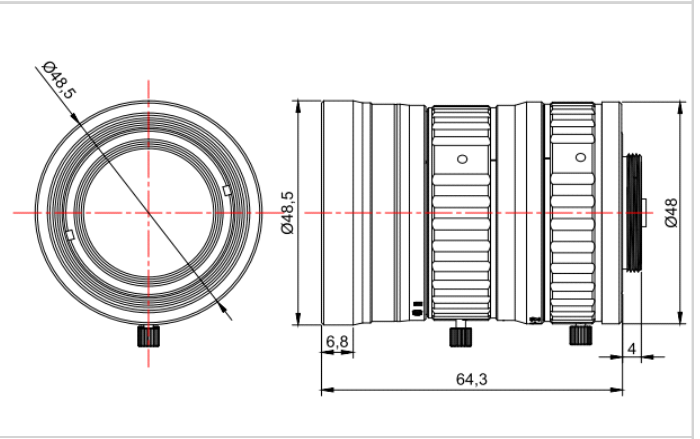

SBS-3520-12MP

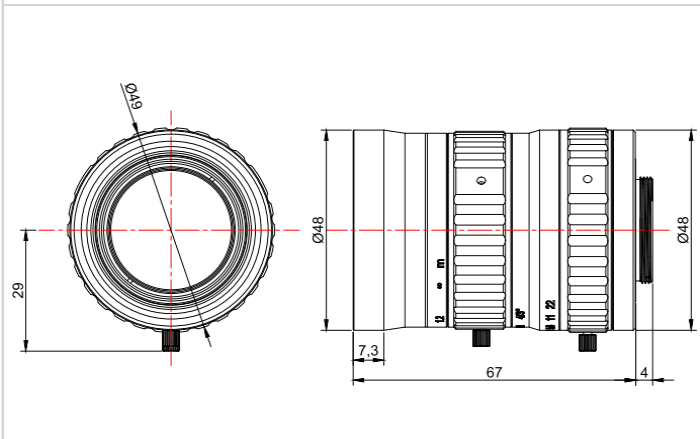

SBS-5020-12MP