



vision solution

# Specification

## SBS-SCJ73-0.308

High Resolution Double Telecentric Lens

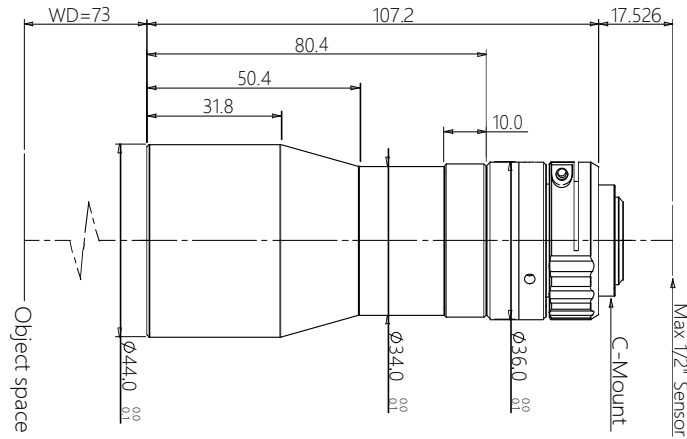

### Features (SBS-SCJ series)

- \* Excellent double telecentric design for high resolution image result.
- \* Field of view is from 26mm to 300mm, suitable for most of application.
- \* Big Iris, low distortion, high parallel degree, big depth of view.
- \* Sensor size is available for 1/2.5" 1/2" 1/1.8" 2/3" 1" 4/3" 1.75" 2" Φ39 35mm full.

### Parameters

FOV (Dia.mm)	26
Mag.(x)	0.308
WD (mm)	73±1
Sensor size (Dia.mm)	8.0(1/2")
Image F#	4.2
Image MTF30(pl/mm)	>175
Object DOF (mm)	±4.6@F11
Object distortion (%)	<0.1
Object telecentric degree	<0.1
Object I/O(mm)	198±1

### Mechanical

Mount	C
Total length (mm)	107.2
N.W(KG)	0.3

### Field of View (mm x mm)

1/2.5" 9P001/31 (5.7x4.28)	18.5x13.9
1/2.3" 9J003 (6.44x4.62)	20.9x15.0