

2/3" 5MP Focal Lens



Products Features

- ▶ Best image comparison.
- ▶ The pixel resolution is 3.45um.
- ▶ Low distortion, high uniformity.
- ▶ The sensor size can match with 2/3" and 1/1.18".

Parameter

NO.	Item No.	Sensor size	Focal length (mm)	Iris (F#)	Resolution	Pixel resolution (um)	Mount	Distortion (%)	Relative illumination (%)	Filter screw size	Working distance (mm)
1	SBS-0816-5MP	2/3"	8	1.6-16	5MP	3.45	C	<0.30	>70	M35.5*P0.5	100-1500
2	SBS-1216-5MP	2/3"	12	1.6-16	5MP	3.45	C	<0.15	>70	M35.5*P0.5	100-1500
3	SBS-1616-5MP	2/3"	16	1.6-16	5MP	3.45	C	<0.10	>70	M35.5*P0.5	100-1500
4	SBS-2516-5MP	2/3"	25	1.6-16	5MP	3.45	C	<0.10	>70	M35.5*P0.5	100-1500
5	SBS-3516-5MP	2/3"	35	1.6-16	5MP	3.45	C	<0.15	>70	M35.5*P0.5	150-1500
6	SBS-5016-5MP	2/3"	50	1.6-16	5MP	3.45	C	<0.05	>70	M40.5*P0.5	300-∞

Model No.	Flange back (mm)	Back focus (mm)	Chief ray angle	Field of view					
				2/3"			1/2"		
				D	H	V	D	H	V
SBS-0816-5MP	17.526 in air	9.00 in air	< 8°	68.0°	57.1°	44.3°	52.6°	43.0°	32.8°
SBS-1216-5MP	17.526 in air	14.04 in air	< 8°	48.1°	39.4°	30.1°	36.0°	29.2°	22.1°
SBS-1616-5MP	17.526 in air	14.90 in air	< 6°	37.8°	30.7°	23.2°	28.0°	22.5°	17.0°
SBS-2516-5MP	17.526 in air	10.45 in air	< 7°	23.3°	18.7°	14.1°	17.1°	13.7°	10.3°
SBS-3516-5MP	17.526 in air	12.52 in air	< 5°	17.3°	13.7°	10.2°	12.5°	10.0°	7.3°
SBS-5016-5MP	17.526 in air	10.88 in air	< 3°	13.2°	10.6°	8.0°	9.6°	7.7°	5.8°

MTF

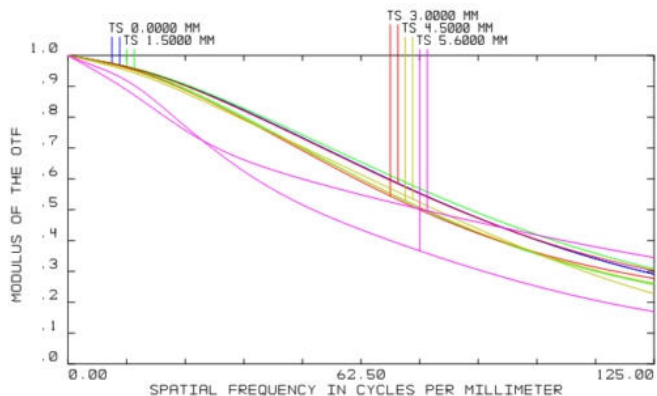

RI

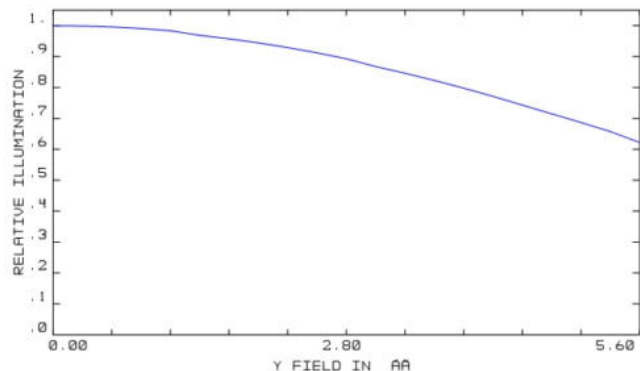

Spot Diagram

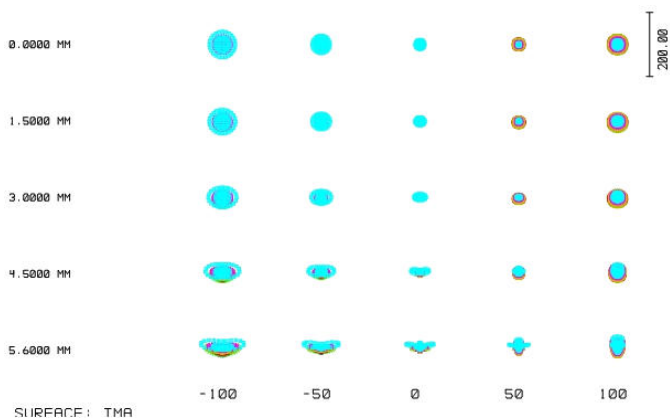

Distortion

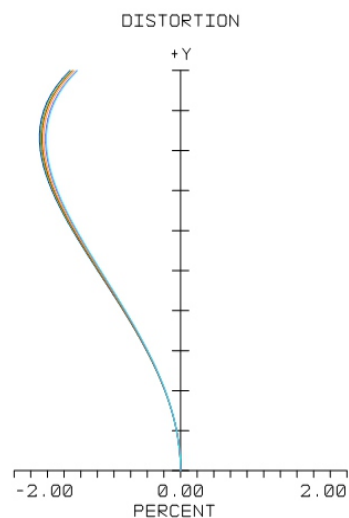

Working distance (mm)	Optical magnification (x)	2/3" Field of view	
		H(mm)	V(mm)
900	0.009	982.06	736.54
800	0.010	875.60	656.70
700	0.011	769.14	576.85
650	0.012	715.90	536.93
600	0.013	662.67	497.00
550	0.014	609.42	457.07
500	0.016	556.18	417.13
450	0.018	502.92	337.19
400	0.020	449.66	337.24
350	0.022	396.38	297.28
300	0.026	343.08	257.31
250	0.030	289.75	217.31
200	0.037	236.37	177.28
150	0.048	182.90	137.18
100	0.069	129.23	96.92

Dimensions(mm)

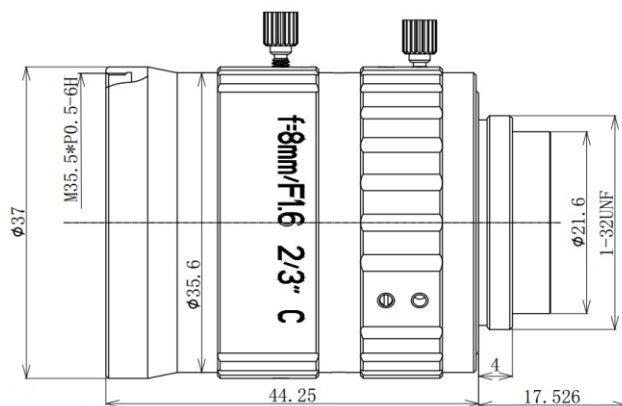



vision solution SBS-1216-5MP

MTF

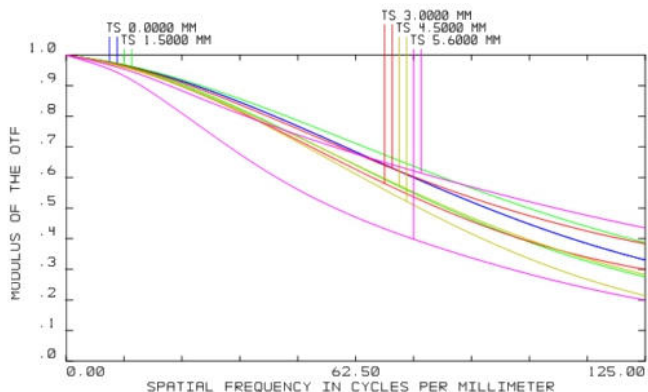

RI

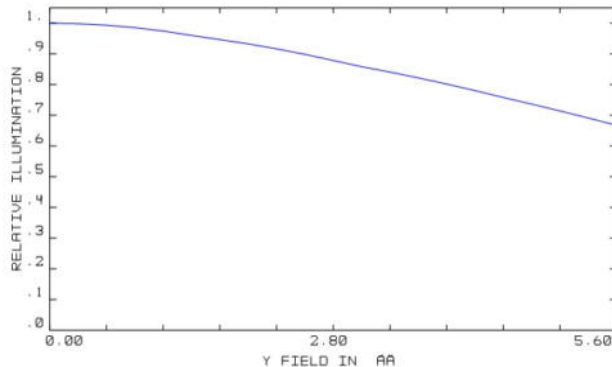

Spot Diagram

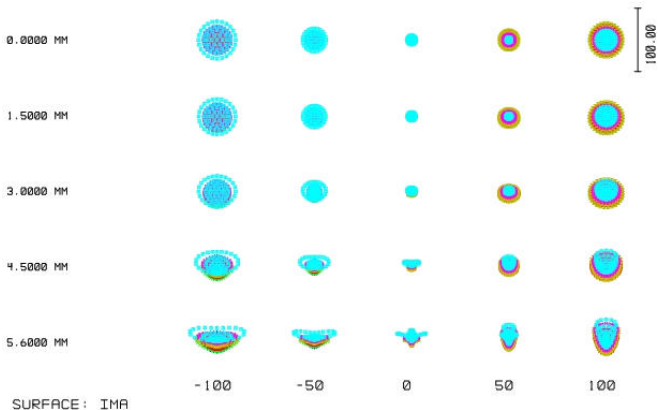

Distortion

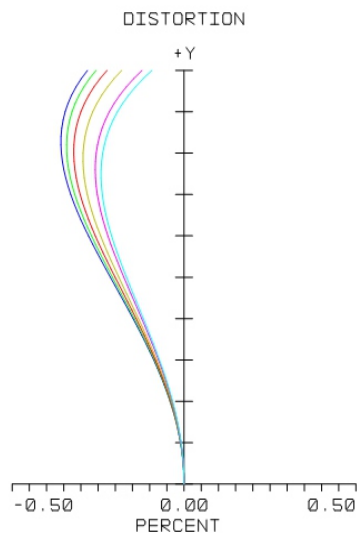

Working distance (mm)	Optical magnification (x)	2/3" Field of view	
		H(mm)	V(mm)
900	0.013	655.55	491.66
800	0.015	584.13	438.09
700	0.017	512.70	384.52
650	0.019	476.98	357.74
600	0.020	441.26	330.95
550	0.022	405.54	304.16
500	0.024	369.82	277.36
450	0.026	334.08	250.56
400	0.030	298.35	223.76
350	0.034	262.60	196.95
300	0.039	226.84	170.13
250	0.046	191.06	143.30
200	0.057	155.25	116.44
150	0.074	119.38	89.54
100	0.106	89.39	62.55

Dimensions(mm)

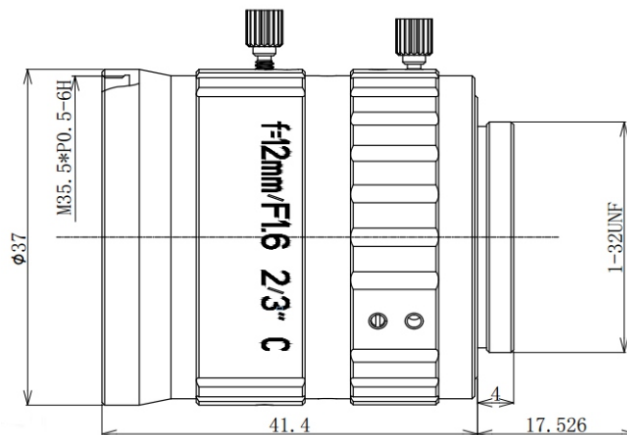

MTF

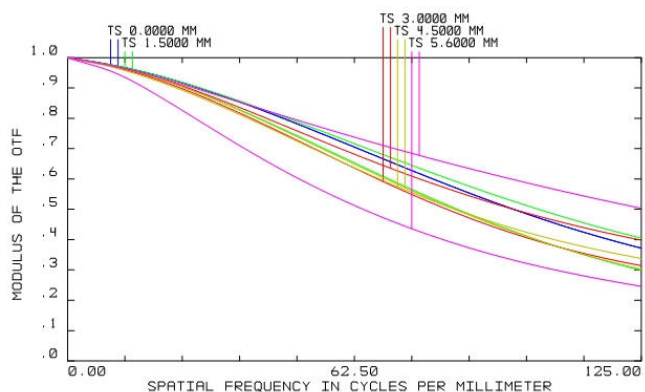

RI

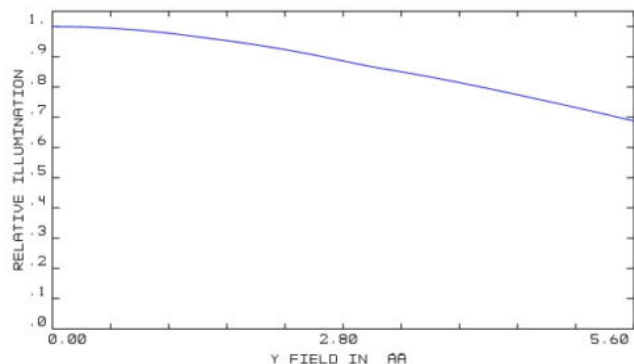

Spot Diagram

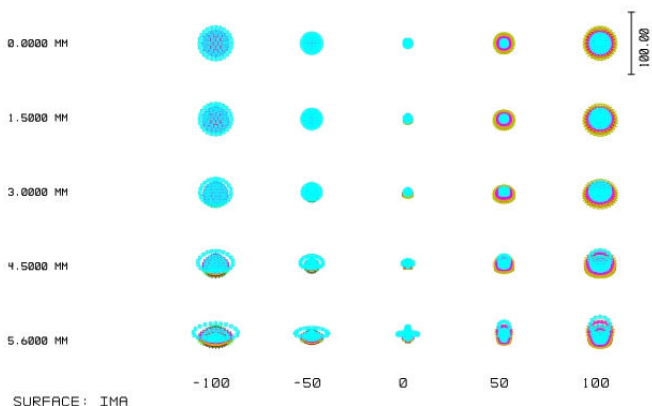

Distortion

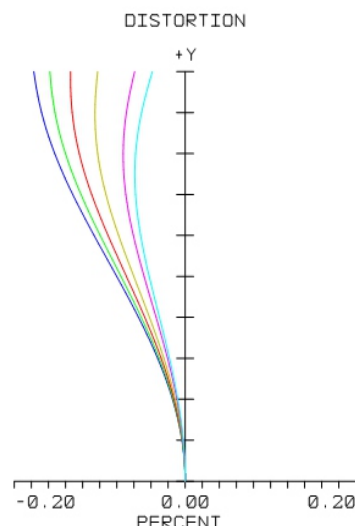

Working distance (mm)	Optical magnification (x)	2/3" Field of view	
		H(mm)	V(mm)
900	0.018	508.96	381.72
800	0.020	453.40	340.05
700	0.022	397.83	298.37
650	0.024	370.05	277.54
600	0.026	342.27	256.70
550	0.028	314.48	235.86
500	0.031	286.70	215.02
450	0.034	258.91	194.18
400	0.038	231.13	173.34
350	0.044	203.34	152.50
300	0.051	175.55	131.66
250	0.060	147.76	110.82
200	0.074	119.97	89.97
150	0.096	92.16	69.12
100	0.138	64.34	48.26

Dimensions(mm)

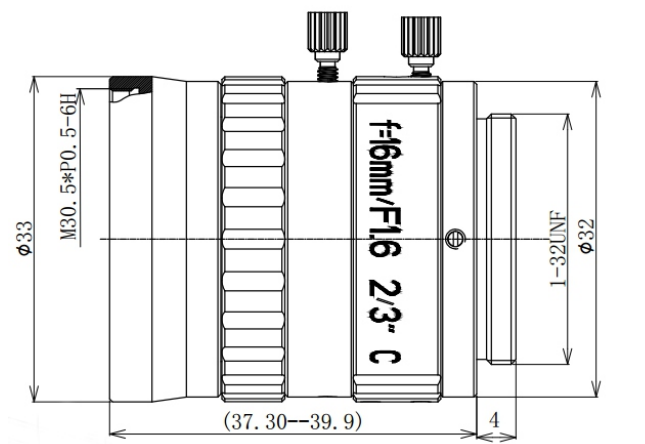



vision solution SBS-2516-5MP

MTF

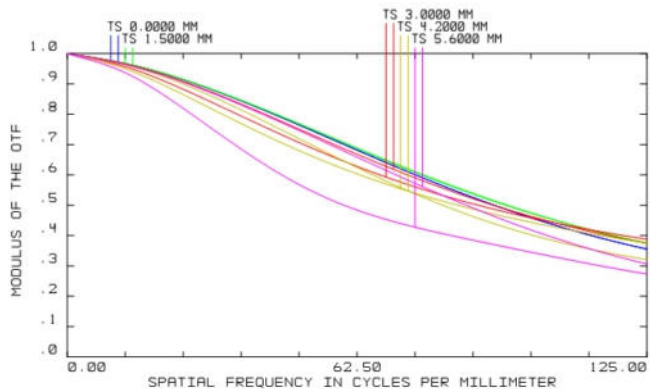

RI

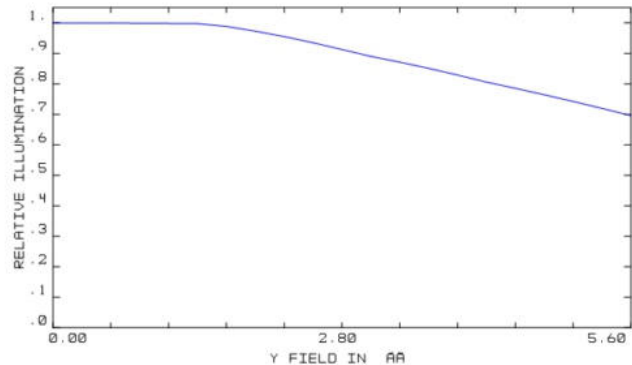

Spot Diagram

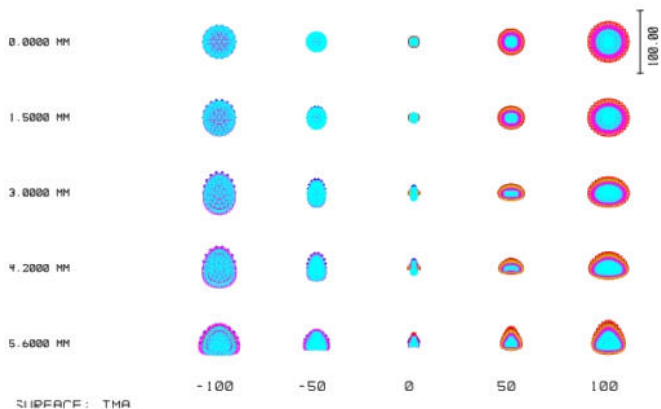

Distortion

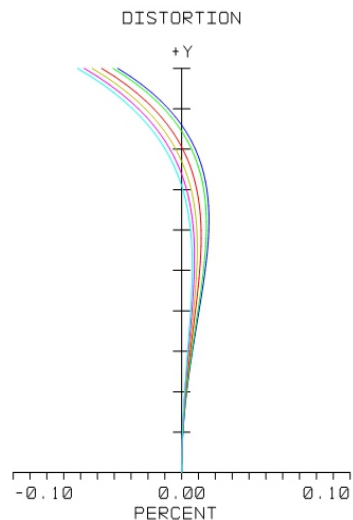

Working distance (mm)	Optical magnification (x)	2/3" Field of view	
		H(mm)	V(mm)
900	0.028	312.47	234.35
800	0.032	277.92	208.44
700	0.036	243.37	182.53
650	0.039	226.09	169.57
600	0.042	208.82	156.61
550	0.046	191.54	143.66
500	0.051	174.26	130.70
450	0.057	156.98	117.73
400	0.064	139.69	104.77
350	0.073	122.41	91.81
300	0.085	105.11	78.84
250	0.102	87.81	65.86
200	0.127	70.50	52.87
150	0.168	53.16	39.87
100	0.250	35.76	26.82

Dimensions(mm)

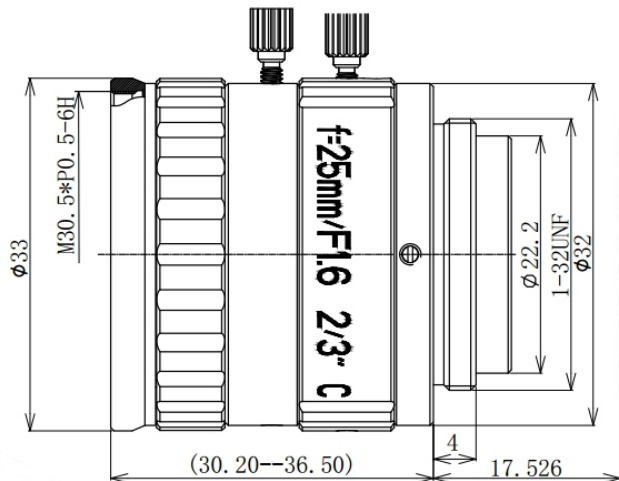

MTF

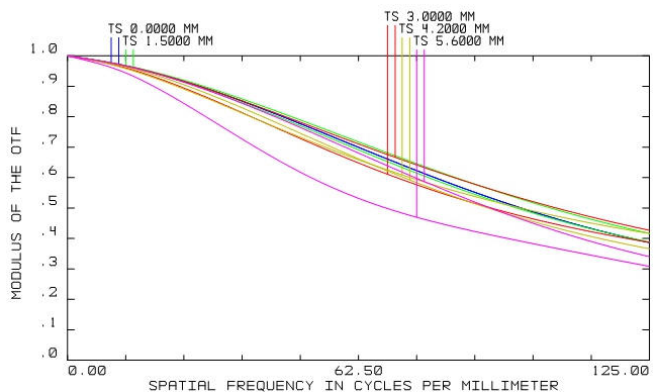

RI

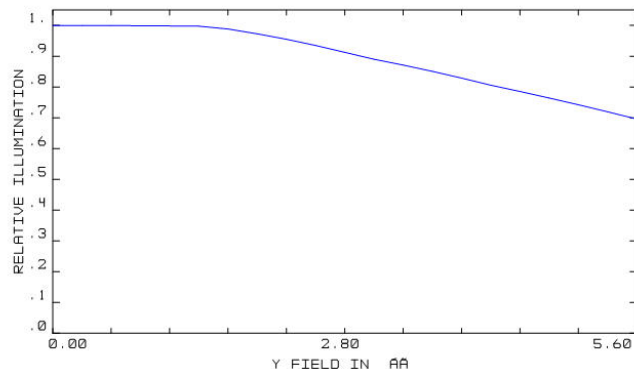

Spot Diagram

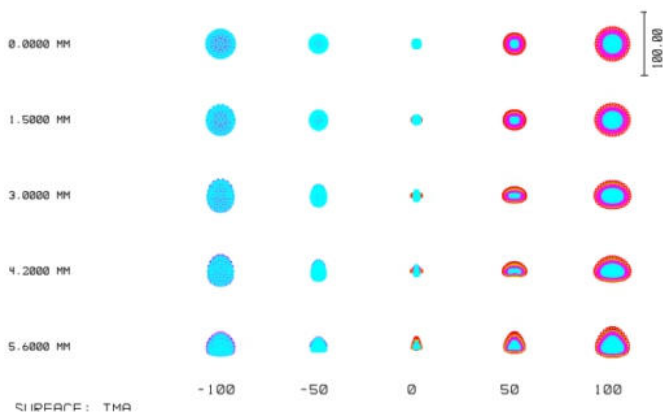

Distortion

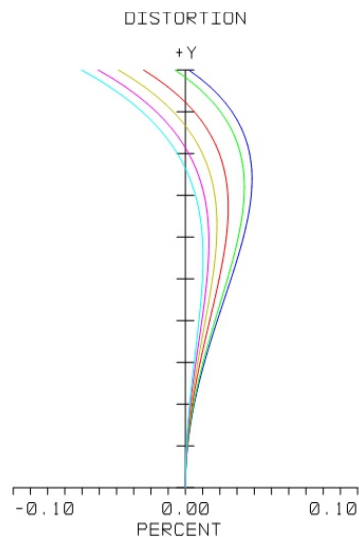

Working distance (mm)	Optical magnification (x)	2/3" Field of view	
		H(mm)	V(mm)
900	0.038	232.70	147.53
800	0.043	207.87	155.90
700	0.045	195.45	146.59
650	0.048	183.03	137.27
600	0.052	170.61	127.96
550	0.056	158.19	118.64
500	0.061	145.77	109.33
450	0.066	133.35	100.01
400	0.073	120.92	90.96
350	0.082	108.50	81.37
300	0.092	96.07	72.05
250	0.106	83.64	62.73
200	0.124	71.20	53.40
150	0.151	58.76	44.07
100	0.191	46.30	34.72

Dimensions(mm)

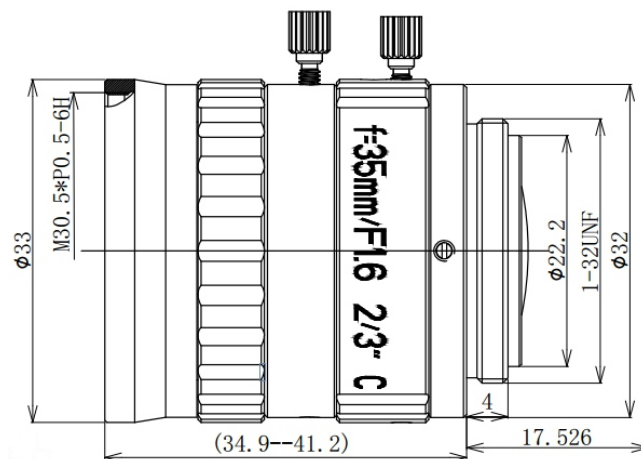



vision solution SBS-5016-5MP

MTF

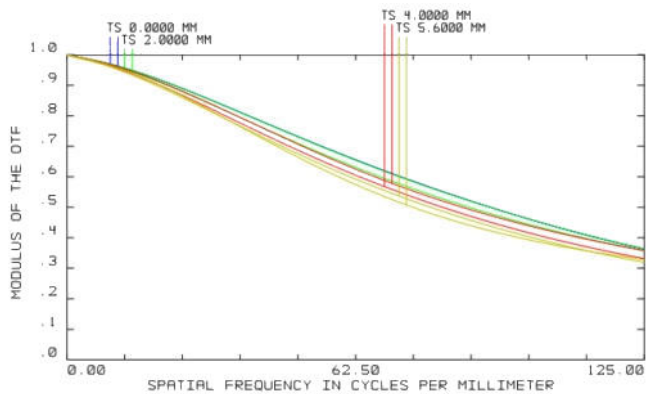

RI

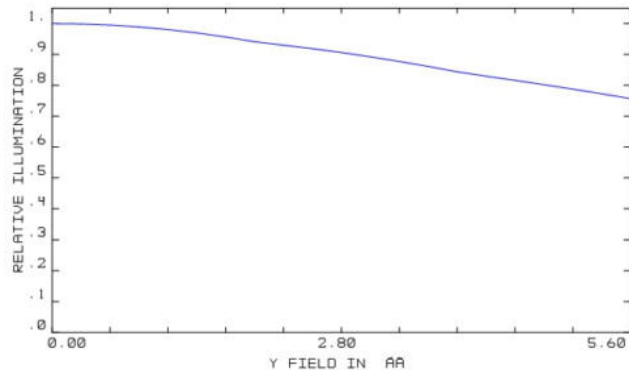

Spot Diagram

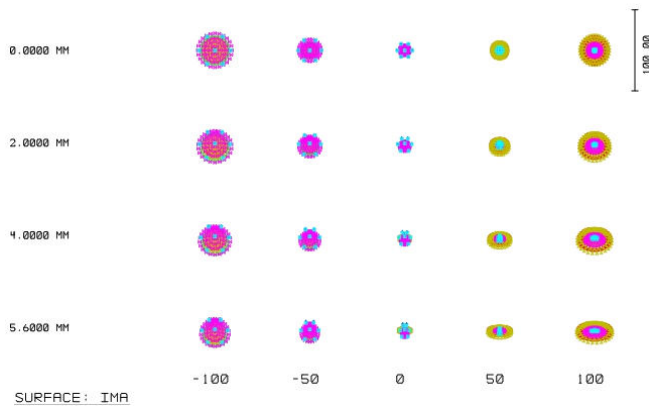

Distortion

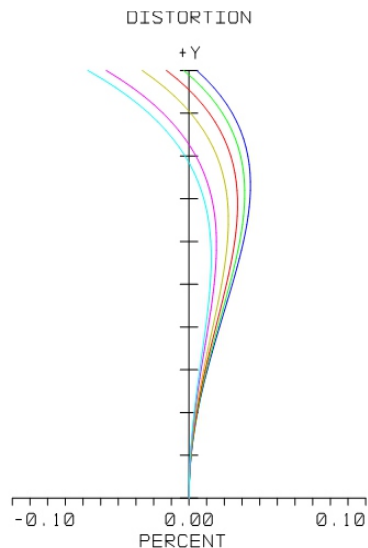

Working distance (mm)	Optical magnification (x)	2/3" Field of view	
		H(mm)	V(mm)
1100	0.044	201.51	151.13
1000	0.048	182.57	136.93
900	0.054	163.65	122.74
850	0.057	154.20	115.65
800	0.061	144.74	108.56
750	0.065	135.29	101.47
700	0.070	125.85	94.39
650	0.076	116.41	87.31
600	0.083	106.97	80.23
550	0.091	97.54	73.16
500	0.100	88.12	66.09
450	0.112	78.69	59.02
400	0.128	69.27	51.95
350	0.148	59.83	44.87
300	0.176	50.35	37.76

Dimensions(mm)

